

Lasnek's 'CL' range of stainless steel electrical conduit systems are designed specifically for use in environments that are particularly corrosive or are subject to strict hygiene control.

Manufactured using either 316L-4404 or 304-1.4403 stainless steel, all conduit is supplied in threaded 3 metre lengths as standard. Manufactured to Lasnek's unique design the fittings, conduit and IP66 boxes, are available for threaded lengths 20, 25, 32mm.

Standard Features - Lengths:

n Material: Annealed 316L - 1.4404 stainless steel or 304 - 1.4301

Welded with internal bead removed

n Dimensions:

3 metres long - threaded each end
Outside Diameter 20, 25 or 32mm

n Finish: 320 grit

n Wall thickness: 1.5mm (1.6 on 32mm)

n Protection: Rated IP66

n UL Listed: File No.E206727

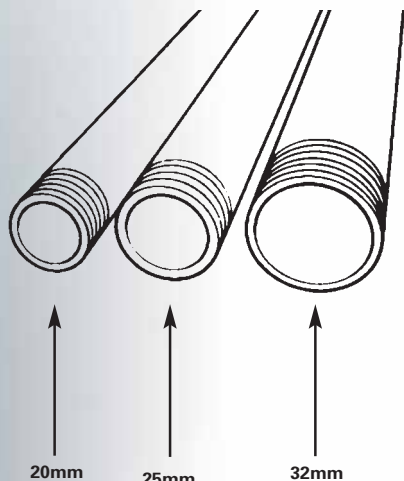

Conduit Lengths - 3m	Size - mm	304 Length Ref.	316L Length Ref.
	20	C-20-CL	A-C-20-CL
	25	C-25-CL	A-C-25-CL
	32	C-32-CL	A-C-32-CL

Conduit Bends	Size - mm	304 Bend Ref.	316L Bend Ref.
	20	C-20-MN	A-C-20-MN
	25	C-25-MN	A-C-25-MN
	32	C-32-MN	A-C-32-MN

Distance Saddles	Size - mm	Ref.
	20	C-20-DS
	25	C-25-DS
	32	C-32-DS

X Deep Saddles	Size - mm	Ref.
	20	C-20-ES
	25	C-25-ES

CONDUIT ACCESSORIES

10mm Munson Ring	Size - mm	Ref.
	20	C-20-MR
	25	C-25-MR
	32	C-32-MR

10mm Double Munson Ring	Size - mm	Ref.
	20	C-20-MR-D
	25	C-25-MR-D
	32	C-32-MR-D

Threaded Rod 10 x **	Size - mm	Ref.
	50	C-XX-MR-S-050
	75	C-XX-MR-S-075
	100	C-XX-MR-S-100

Lock Ring	Size - mm	Ref.
	20	C-20-LR
	25	C-25-LR
	32	C-32-LR

Stop Plugs	Size - mm	Ref.
	20	C-20-SP
	25	C-25-SP
	32	C-32-SP

Die Head	Size - mm	Ref.
	20	C-20-DH
	25	C-25-DH
	32	C-32-DH

CL RANGE CONDUIT SYSTEM & ACCESSORIES

Ratchet Stock	Size	Ref.
	—	C-00-RS



Hook Plate	Size	Ref.
	—	C-XX-HP



MISC ITEMS

Jack Chain	Size	Ref.
	1 metre	C-XX-JC-300
	10 metre	C-XX-JC-300-10

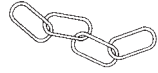

Munson Base	Size	Ref.
	M10	C-XX-MR-B

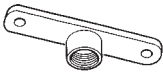

Reducer	Size - mm	Ref.
	25-20	C-25-20
	32-20	C-32-20
	32-25	C-32-25



Neoprene Washer	Size - mm	Ref.
	20	C-20-NW
	25	C-25-NW
	32	C-32-NW



Nipple Short	Size - mm	Ref.
	20	C-20-NS
	25	C-25-NS
	32	C-32-NS

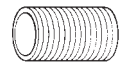

Nipple Long	Size - mm	Ref.
	20	C-20-NL
	25	C-25-NL
	32	C-32-NL



To complement the conduit lengths the Lasnek 'CL' range also incorporates the widest range of BESA boxes and accessories.

All BESA boxes are IP66 rated and have been manufactured to Lasnek's designs from 316L - 1.4404 stainless steel. The Lasnek 'CL' range continues to set the standards for quality and design.

Standard Features - Besa Boxes:

- n Dimensions: 65mm diameter for 20 & 25mm units
80mm diameter for 32mm units
- n Entries: Choice of 1, 2, 3 & 4 way configurations
- n Material: 316L - 1.4404
- n Finish: Electro polished
- n Protection: IP66
- n Cover: Complete with lid screws and gasket
- n Earth Studs: Included
- n Accessories: 316L - 1.4404 available for all sizes

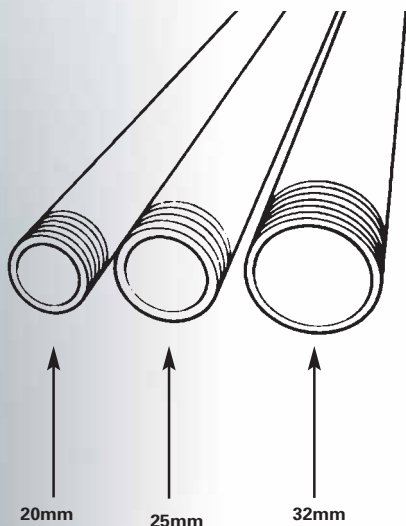



CONDUIT ACCESSORIES

Lock Nut	Size - mm	Ref.
	20	C-20-LN
	25	C-25-LN
	32	C-32-LN

Female Bush	Size - mm	Ref.
	20	C-20-FB
	25	C-25-FB
	32	C-32-FB

Male Bush	Size - mm	Ref.
	20	C-20-MB
	25	C-25-MB
	32	C-32-MB

Flange Coupler	Size - mm	Ref.
	20	C-20-FC
	25	C-25-FC
	32	C-32-FC

Coupling	Size - mm	Ref.
	20	C-20-SC
	25	C-25-SC
	32	C-32-SC

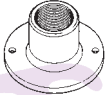
Dome Lid	Size - mm	Ref.
	20	C-20-DL
	25	C-25-DL

BESA BOXES

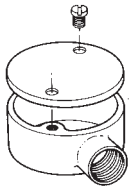
End Box	Size - mm	Ref.
	20	C-20-EB
	25	C-25-EB
	32	C-32-EB

Straight Box	Size - mm	Ref.
	20	C-20-SB
	25	C-25-SB
	32	C-32-SB

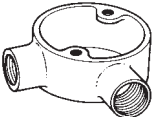
Angle Box	Size - mm	Ref.
	20	C-20-AB
	25	C-25-AB
	32	C-32-AB

CL RANGE CONDUIT SYSTEM & ACCESSORIES

Tee Box	Size - mm	Ref.
	20	C-20-TB
	25	C-25-TB
	32	C-32-TB

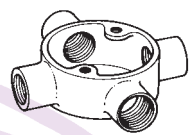
4 Way Intersection Box	Size - mm	Ref.
	20	C-20-FW
	25	C-25-FW
	32	C-32-FW

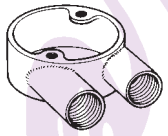
U Box	Size - mm	Ref.
	20	C-20-UB

Branch 3 Way	Size - mm	Ref.
	20	C-20-YB

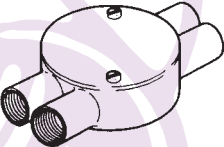
Twin Through Box	Size - mm	Ref.
	20	C-20-TS

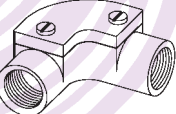
Inspection Elbows	Size - mm	Ref.
	20	C-20-IE

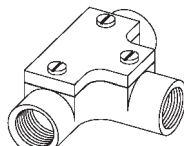
Inspection tees	Size - mm	Ref.
	20	C-20-IT

Solid Elbows	Size - mm	Ref.
	20	C-20-NE

